

NÁHRADNÉ DIELY PÁSOVÝCH LISOV CENED

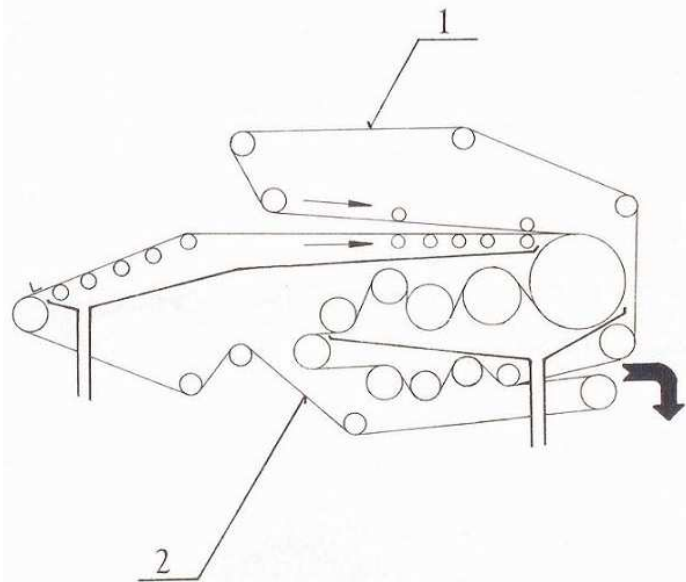

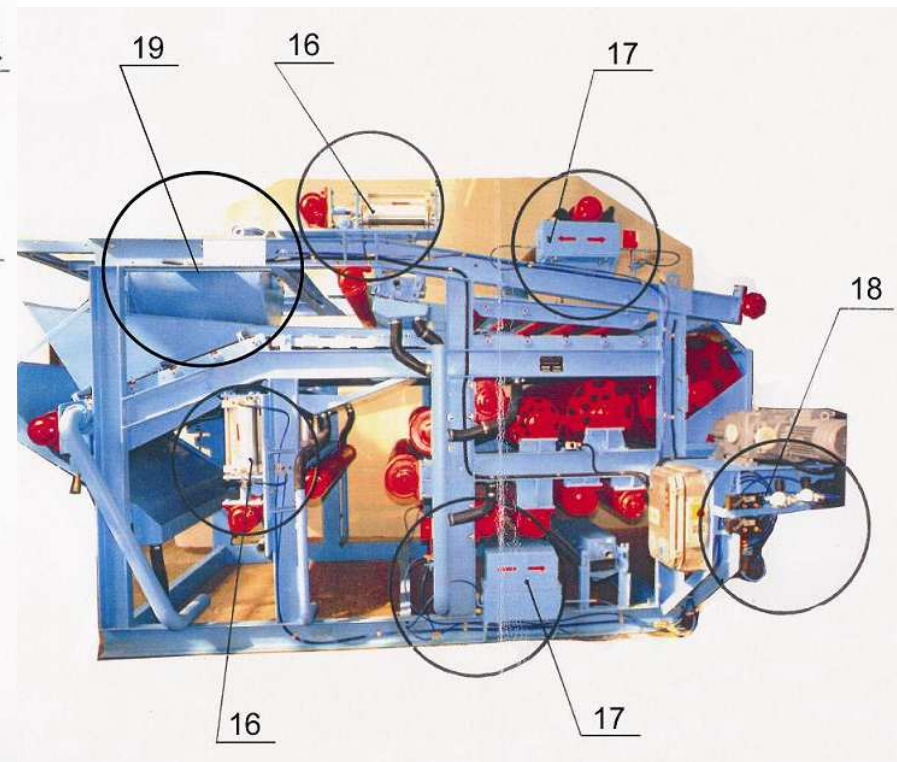

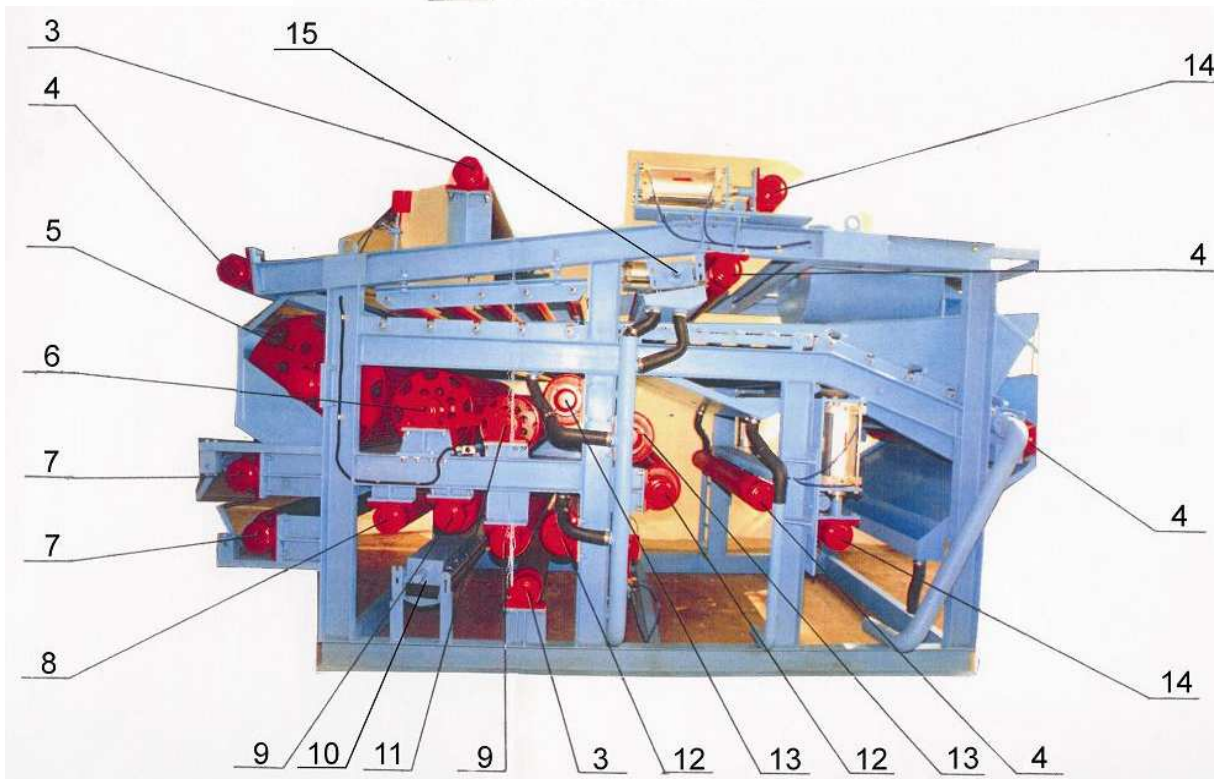

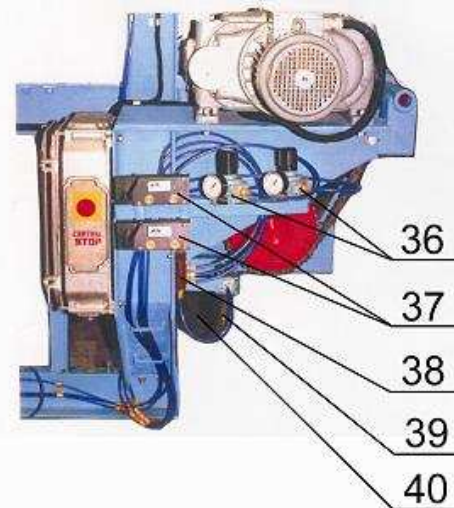
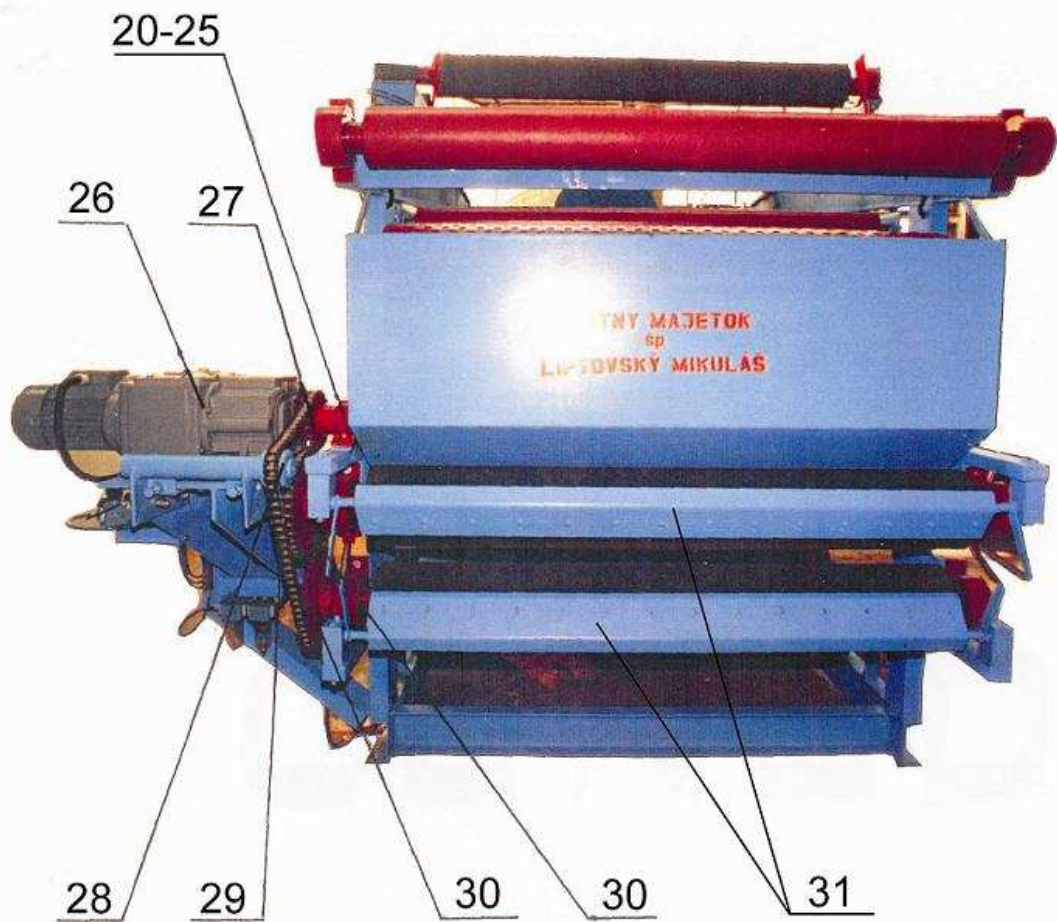









Pri objednávaní je potrebné uviesť typ pásového lisu.











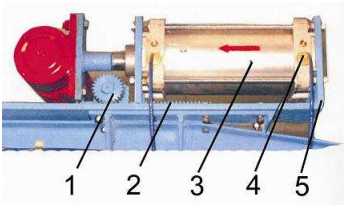
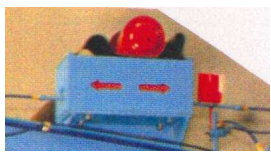





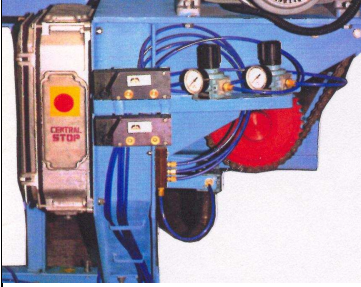

35

POZ.	ZOBRAZENIE	NÁZOV	DIELEC	KATAL. ČÍSLO	KUSY (1 lis)	POZNÁMKA
<u>1</u>		Vrchné pásové sito	Vrchné pásové sito	SSV 01-2	1	Dížky sít prekonzultovať s firmou VANEX – uviesť taktiež typ zariadenia.
<u>2</u>		Spodné pásové sito	Spodné pásové sito	SSS 02-0	1	Dížky sít prekonzultovať s firmou VANEX – uviesť taktiež typ zariadenia.
<u>3</u>		Regulačné valce	Regulačné valce	SGF 03-0	2	
<u>4</u>		Vodiace valce	Vodiace valce	SPM 04-0	4	
<u>5</u>		Dierovaný valec (5)	Dierovaný valec Ø 720	SSC 05-2	1	
<u>6</u>		Dierovaný valec (6)	Dierovaný valec Ø 426	SPV 06-0	1	
<u>7</u>		Valce pohonu	Valce pohonu	SKC 07-1	2	





<u>8</u>		Lisovací valec (8)	Lisovací valec Ø 150	SVV 08-0	1	
<u>9</u>		Lisovacie valce (9)	Lisovacie valce Ø 219	SGL 09-0	2	
<u>10</u>		Spodný oplach	Oplachová rúra s tryskami	SRO 10-1	1	
			Guma oplachu	SGO 10-2		
			Žľab oplachu	SZO 10-3		
<u>11</u>		Dierovaný valec (11)	Dierovaný valec Ø 324	SSN 11-0	1	
<u>12</u>		Lisovacie valce (12)	Lisovacie valce Ø 245	SVR 12-0	2	
<u>13</u>		Lisovacie valce (13)	Lisovacie valce Ø 273	SLV 13-0	2	
<u>14</u>		Napínacie valce	Napínacie valce	SDV 14-0	2	

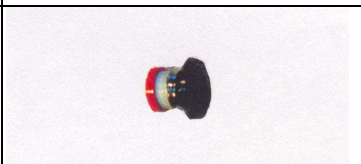
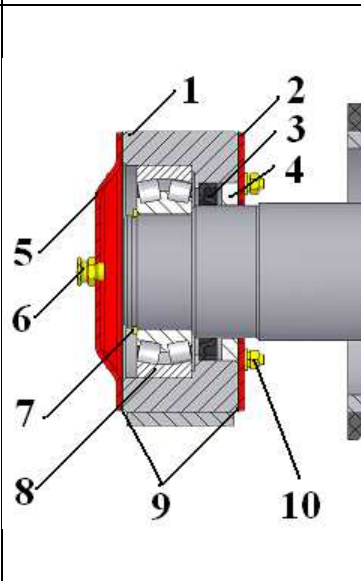

<u>15</u>		Vrchný oplach	Oplachová rúra s tryskami	SRO 15-1	1	
			Guma oplachu	SGO 15-2		
			Žľab oplachu	SZO 15-3		
<u>16</u>		Napínanie sít pásového lisu	Ozubené koleso	SBK 16-1	4	
			Hrebeň napínania	SBH 16-2		
			Pneumatický vzduchový valec	SBV 16-3		
			Redukcia	SBR 16-4	8	
			Rám napínania	SBT 16-5	4	
<u>17</u>		Regulácia pásového lisu	 Pneumatický vzduchový valec	SAV 17-1	2	
			 Tesnenia vzduchového valca	SAX 17-2		
			 Rám regulačného valca	SAT 17-3	4	
			 Lapka regulácie	SAL 17-4		
			 Ventil	SAV 17-5	4	
<u>18</u>		Ovládacia a úpravná jednotka tlakového vzduchu	36  Regulátor tlaku napnutia sít s manometrom	SCR 18-36	2	
			37  Ovládací ventil napnutia sít	SCV 18-37	2	
			38  Rozvodný šesťhran	SCS 18-38	1	
			39  Maznica	SCM 18-39	1	
			40  Odlučovač vlhkosti	SCO 18-40	1	

<u>19</u>		Zmiešavací valec	Motor miešadla	SZM 19-1	1	
			Bubon	SZT 19-2		
<u>20 - 25</u>		Domec pohonových valcov	Teleso domca	SFC 20-1	2	Časti domca pohonového valca sú rovnaké ako pri ostatných domcoch valcov.
			Vonkajšie veko (priechodzie)	SFV 20-2		
<u>26</u>		Pohon	Pohon	SVK 26-0	1	
<u>27</u>		Hnacie koleso	Hnacie koleso	SLK 27-0	1	
<u>28</u>		Napínacia kladka	Napínacia kladka	SNK 28-0	1	
<u>29</u>		Reťaz	Reťaz	SRP 29-0	1	(2,5 m)
<u>30</u>		Reťazové koleso pohonu – hnané	Reťazové koleso pohonu – hnané	SPK 30-0	2	
<u>31</u>		Stieranie	Lišta stierania	SXL 31-1	2	
			Pružina	SXP 31-2	4	
			Teleso stierania	SXS 31-3	2	

<u>32</u>		Gravitačné lišty	Lišty	SQA 32-0	5	
<u>33</u>		Lapka vybočenia sita	Lapka vybočenia sita	SUE 33-0	2	
<u>34</u>		Koncové elektrické čidlo	Koncové elektrické čidlo	SMC 34-0	2	
<u>35</u>		Stop tlačítko	Stop tlačítko	SNS 35-0	1	
<u>36-40</u>	Zahrnuté v pozícii č. 18					
<u>41</u>		Domec valca	1. Teleso domca	SDL 41-1	40	
			2. Vnútorne veko	SDL 41-2	40	
			3. Gufero	SDL 41-3	40	
			4. Plst'ový krúžok	SDL 41-4	40	
			5. Vonkajšie veko	SDL 41-5	40	
			6. Maznica	SDL 41-6	40	
			7. Poistný krúžok	SDL 41-7	40	
			8. Dvojradowé ložisko	SDL 41-8	40	
			9. Papierové tesnenie	SDL 41-9	160+160+160	
			10. Skrutka + podložky + matica	SDL 41-10	40	

Náhradné diely konektorov pre vzduchový systém lisov

Zobrazenie konektoru	Pripojovacie rozmery		Katalógové číslo
	Závit	Hadička	
	1/8"	ø 8	V-6512-8
	1/4"		V-6512-4
	1/8"	ø 8	V-6610-8
	1/4"		V-6610-4
	1/4"	2 x ø 8	V-6620-0
	1/8"	-	V-1631-8
	1/4"		V-1631-4
	-	2 x ø 8	V-6580-0

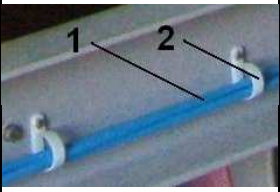
	-	2 x \varnothing 8	V-6550-0
	-	3 x \varnothing 82 x \varnothing 82 x \varnothing 8	V-6540-0
	-	4 x \varnothing 8	V-6600-0
	-	Hadička \varnothing 8	V-VH-0
		Objímka	V-OV-0